

High-Resolution 2D Sensor

High Precision Optical Sensor with Enhanced Illumination

2D SENSOR

Measure. Analyze. Improve.

CyberOptics is a leading global developer and manufacturer of high precision sensing technology solutions. CyberOptics' 2D and 3D sensors are used in SMT, semiconductor and metrology markets to significantly improve yields and productivity.

New 2D Sensor with Enhanced Illumination

CyberOptics High-Resolution 2D Sensor provides perfect, crisp quality images at a 3 μ m resolution. The four independent white light LED ring light channels provide a great degree of flexibility for inspection and defect review.



Lens Inspection - Bubble Defect

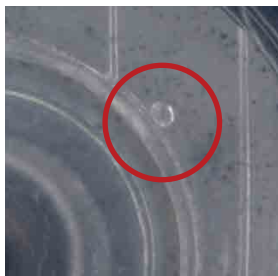

Packaging - High Angle

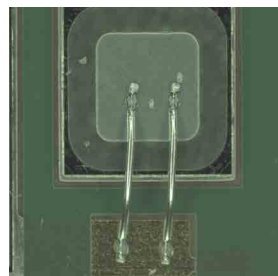
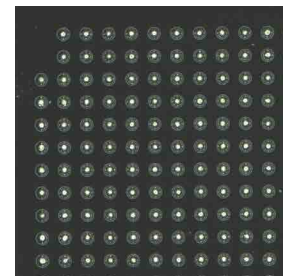
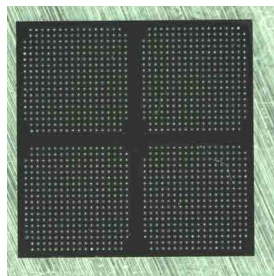

Wire Bond - High Angle

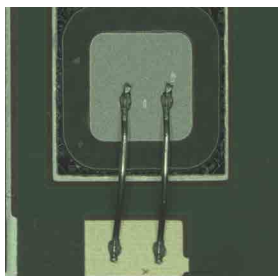

Wire Bond - Low Angle

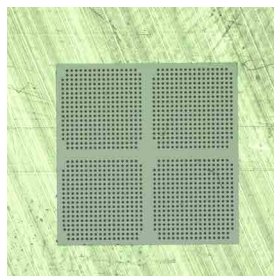

Packaging - Coaxial

Metrology-Grade Accuracy at Production Speed

- See crisp, high quality images for highly accurate inspection and defect review.

Superior Inspection Performance

- Attain repeatable and reproducible measurements for a variety of applications.

Versatility for Various Challenging Applications

- Ideal for a wide range of applications including wire bond, advanced packaging, solder bump & ball, lens inspection and other applications where an even greater degree of accuracy and reliability is critical.

Intuitive, Easy-to-Use Software

CyberOptics AOI Software is a powerful yet extremely simple software designed with an intuitive interface that reduces training efforts and minimizes operator interaction – saving time and cost. The software includes multi-touch controls and image visualization tools, taking ease-of-use to a whole new level.

AI² - Faster, Smarter Programming

Autonomous Image Interpretation (AI²) technology is all about keeping it simple - no parameters to adjust or algorithms to tune. With AI², you have the power to inspect the most comprehensive list of features and identify the widest variety of defects. AI² offers precise discrimination with just one panel inspection making it a perfect solution for high-mix and high-volume applications.



AOISoftware

Sensor Specifications

| | |
|------------------------|---|
| Field of View | 15 x 15mm |
| Resolution | 3 μ m |
| Depth of Field | \pm 250 μ m |
| Inspection Rate | 7 cm ² /sec |
| Imaging System | Telecentric |
| Illumination | Four Independent White Light LED Ring Light Channels <ul style="list-style-type: none"> • Coaxial (90°) • High Angle (70°) • Medium Angle (50°) • Low Angle (40°) |

System Specifications

| | |
|------------------------------------|--|
| Machine Interface | SMEMA, RS232 and Ethernet |
| Power Requirements | 100-120 VAC or 220-240 VAC, 50/60 hz, 10-15 amps |
| Compressed Air Requirements | 5.6 Kg/cm ² to 7.0 Kg/cm ² (80 to 100 psi @ 4 cfm) |
| System Dimensions | 110 x 127 x 145 cm (W x D x H) |
| Weight | 965 kg (2127 lbs.) |

Options

Barcode Reader, Rework station, SPC Software, Alignment Target

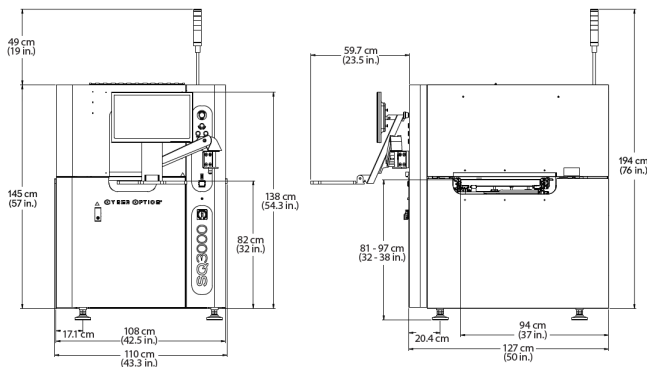

CYBEROPTICS

Contact CyberOptics today for more information

+1 800.366.9131 or +1 763.542.5000 | CSales@cyberoptics.com | www.cyberoptics.com

Copyright © 2019. CyberOptics Corporation. All rights reserved. Specifications subject to change without notice 8027178 Rev B